

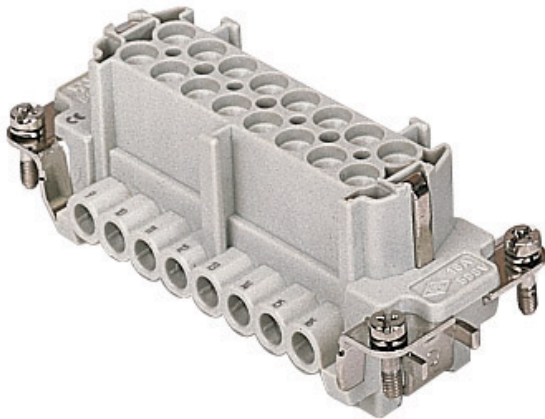



Part number

CNEF 16 TN



Brief description:

female insert, 16 poles + PE, No. 17 - 32, screw terminal connections, 16A, 500V, 6kV, 3, silver plated, size "77.62", CLASS insert series

Product description		Approvals / Standards	
Model	female insert	Reference standard	EN 61984 (2001-11)
Version	screw terminal connections	Quality mark	   EAC
Series	CNE	Conformity	CQC, CE
Product type	with female contacts	General ordering information	
Variant	with plate	EAN13 code	8015747032377
Family	CLASS inserts	Tariff number	85369095
Size	size "77.62"	Country of origin	Made in EU (IT)
N. of poles	32 poles +  (2 inserts)	ETIM classification	EC000438
Technical data		Packaging Information	
Current	16 A (A.C. and D.C.)	Packaging length	210,00 mm
Voltage	500 V	Packaging height	75,00 mm
Rated impulse withstand voltage	6kV	Packaging width	180,00 mm
Pollution degree	3	Packaging weight	3,00 kg
Wire cross-section	0,50 mm ² - 4,00 mm ²	Packaging volume	2,84 dm ³
AWG size	20 - 12	Packaging description	Carton box
Operating temperature range (min, max)	-50°C ... +70°C	Packaging quantity	30 Pcs
Contact type	silver plated	Packaging EAN code	8015747032384
Mating cycles	≥ 200	Sub-packaging length	87,00 mm
IP degree of protection	IP20 without enclosure, IP65/IP66 with enclosure	Sub-packaging height	36,00 mm
PE terminal stripping length	7 mm	Sub-packaging width	180,00 mm
PE wire cross-section	0,14 - 4 mm ² ; AWG 20 - 12	Sub-packaging weight	0,50 kg
Further technical details		Sub-packaging volume	0,56 dm ³
Characteristics according to EN 61984	16A 500V 6kV 3; 16A 400/690V 6kV 2	Sub-packaging description	Carton
Insulation resistance	≥ 1 GΩ	Sub-packaging quantity	5 Pcs
Rated voltage according to UL/CSA	600V	Sub-packaging EAN barcode	8015747032391
UL 94 flammability rating	V-0		
Weight	100,00 g		

Part number

CNEF 16 TN



Catalogue drawings

Catalogue drawings

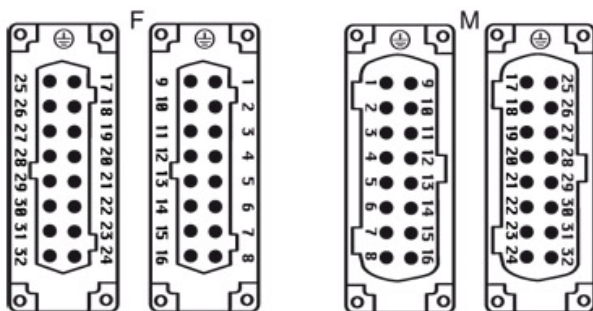
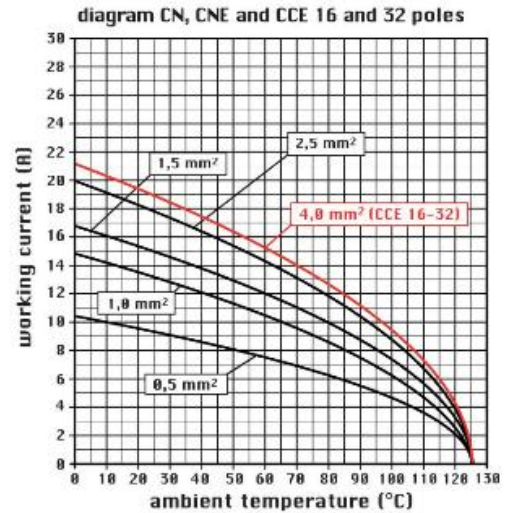
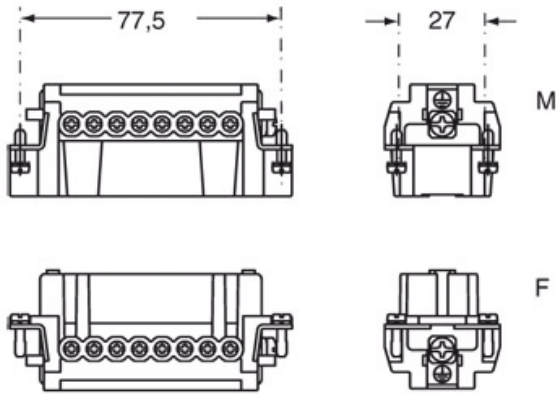

Notes

CNEF/M 16 TN/TXN inserts:

- characteristics according to EN 61984:
(16A 500V 6kV 3)
(16A 400/690V 6kV 2)
- rated voltage according to UL/CSA: 600V
- insulation resistance: > 10 GOhm
- ambient temperature limit: -40 °C ... +125 °C
- are made of self-extinguishing thermoplastic resin UL 94 V0
- mechanical life: > 500 cycles
- contact resistance: < 1 mOhm
- enclosures: size "77.62":

C-TYPE IP65/IP66
W-TYPE aggressive environments

CNE ... : for non-prepared conductors



CNE ... X : for conductors with bush terminal
